

FRONT ELEVATION  
DOUBLE GARAGE

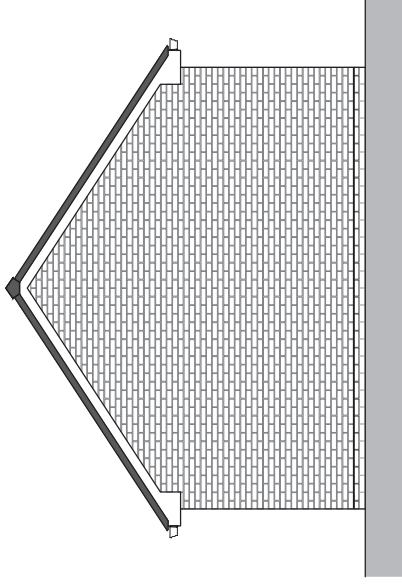

SIDE ELEVATION

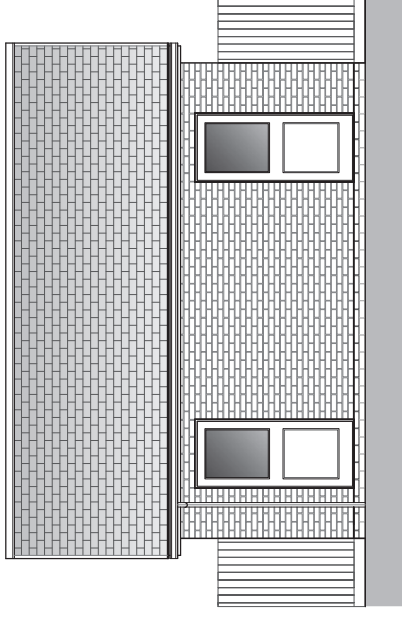

REAR ELEVATION

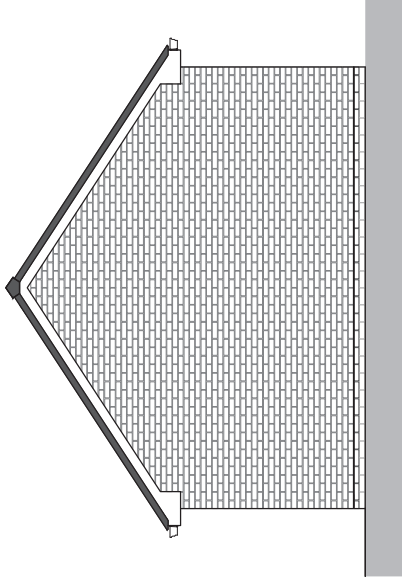

SIDE ELEVATION

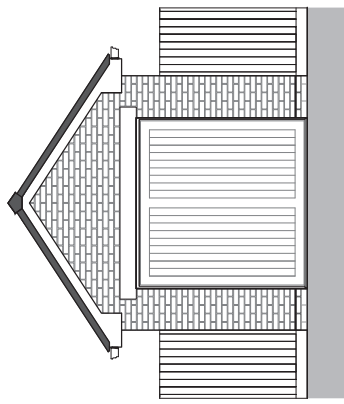

FRONT ELEVATION  
SINGLE GARAGE

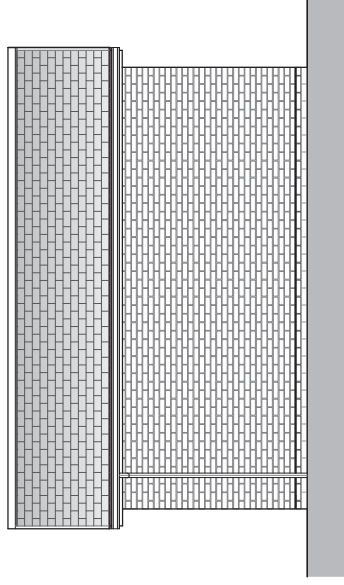

SIDE ELEVATION

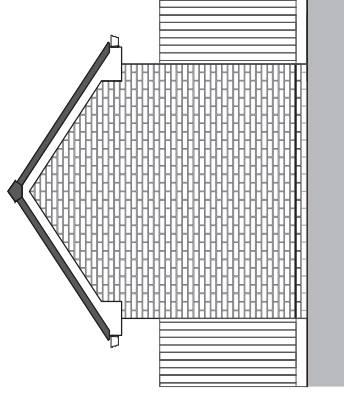

REAR ELEVATION

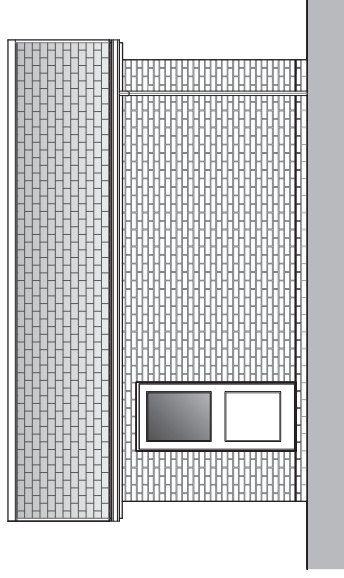

SIDE ELEVATION

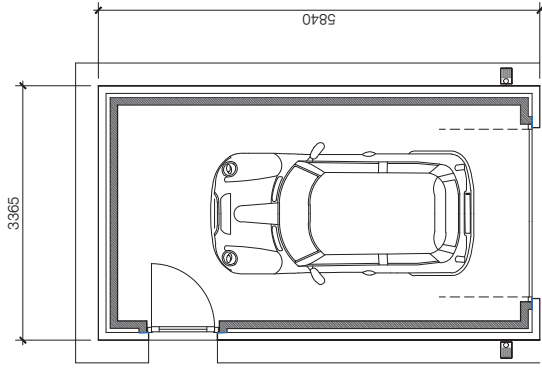

PLAN  
SINGLE GARAGE

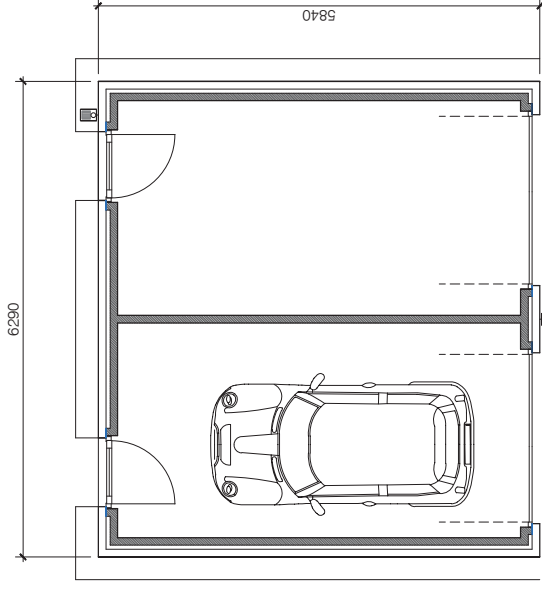

PLAN  
DOUBLE GARAGE

MANNINGELLIOTT  
PARTNERSHIP

Chartered Architects &  
Designers

Members of the Institution of  
Chartered Architects (IACA)  
Chartered Surveyors (RICS)

T: 01753 663800  
E: [info@manningelliott.co.uk](mailto:info@manningelliott.co.uk)  
W: [www.manningelliott.co.uk](http://www.manningelliott.co.uk)

PLANS & ELEVATIONS  
SINGLE & DOUBLE GARAGE

scale @ A1/A3:  
1:50/100

drawing number:  
GARAGE S101-110